

OPTIMAL STOCHASTIC CONTROL OF THE MODES OF OPERATION OF THE SEWAGE PUMPING STATION

A. Tevyashev¹, G. Nikitenko², O. Matviyenko³

¹Kharkiv National University of Radio Electronics; e-mail: tad45@mail.ru

²ME «Kharkovvodokanal»; e-mail: gynikitenko@mail.ru

³Kharkiv National University of Radio Electronics; e-mail: olga_mat@ukr.net

Received: accepted

Abstract: In this work we propose a new mathematical model and method of optimal stochastic control of the modes of operation of the sewage pumping station for three-band tariff for the electricity, the implementation of which provides a significant reduction of financial expenses of the electricity for pumping waste water. The proposed model and method take into account the stochastic properties of the object of control and environment most adequately. The mathematical formulation of the problem of optimal stochastic control with extreme and probabilistic constraints on the phase variables and efficient algorithm to solve it is presented. The proposed method of optimal stochastic control provides minimum of the mathematical expectation of the volumes of pumped waste water at the time interval with a high electricity tariff and maximum of the mathematical expectation of the volumes of pumped waste water at the time interval with a minimal tariff when all technological limitations are accomplished.

Keywords: optimal stochastic control, sewage pumping station, receiving tank, three-band tariff for the electricity, efficient use of resources.

INTRODUCTION

In the urban sector of modern cities the expenses for the electricity in supply and sanitation systems occupy about 25% of total operating costs in water supply systems [1, 13, 15, 18, 26]. Significant increase of the electricity tariffs has led to the urgent need in development and implementation of energy-saving technologies of the operation of the sewage pumping station (SPS) [12, 14]. Specific features of SPS like relatively small receiving tank capacity (RT), severe restrictions on the conditions of its overflow or emptying (emergencies) and the single-band tariff for the electricity have turned to widespread of classical deterministic strategies of the operation of pump units (PU) of SPS.

The classical strategy of the operation of PU of SPS is in the following: all acceptable range of the variation of the levels of waste water (WW) in RT is divided into several levels (thresholds); if the level of WW in RT of SPS exceeds the predetermined threshold, an additional PU is switched on; if the

level of WW in RT of SPS keeps rising and exceeds the following threshold, another additional PU is switched on and this process goes on until all PU of SPS are switched on. If the level of WW in RT of SPS continues to rise and exceeds the maximum allowable level then in order to avoid flooding of the room of SPS an alarm reset of WW from RT into surface water is carried out. When the level of WW reduces lower than the predetermined threshold PU on SPS is switched off. If the level of WW in RT becomes lower than minimum allowable level then all PU on SPS are switched off [3-6, 10].

Such a strategy proved to be extremely simple and quite safe and it is widely used in the practice of the operation of PU of SPS for one-band tariffs for the electricity. [9]

The problem of optimal stochastic control of the modes of operation of SPS while its transition to three-band tariff for the electricity is examined in the present work. At that SPS is considered as a stochastic object operating in the stochastic environment. The stochastic nature of the environment can be seen in the fact that the processes of inflow of WW in RT of SPS (inputs of the object of control) have pronounced random character depending on a variety of chronological, meteorological and organizational factors [8, 27]. The stochastic nature of the object of control is seen in the fact that the parameters of the technological equipment of SPS are unknown a priori, but they are estimated according to the experimental data of the final length, which are random variables [21-25, 7]. The consideration of real conditions of the functioning of SPS, the development and use of more adequate mathematical models of technological equipment of SPS and three-band tariff for the electricity make it possible to build more cost-effective methods of control of the modes of operation of SPS at a given interval of control [0, T].

THE MATHEMATICAL FORMULATION OF THE PROBLEM OF OPTIMAL STOCHASTIC CONTROL OF THE MODES OF OPERATION OF SPS

The cost of the electricity is determined by the diagram of three-band tariff, given in Fig. 1.

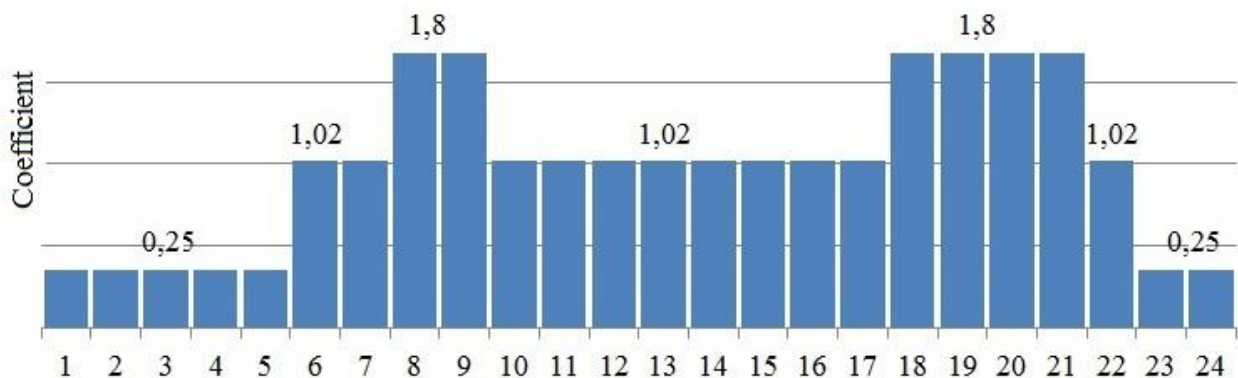

Fig. 1. The diagram of three-band tariff for the electricity

Without loss of generality, we give the mathematical formulation of the problem of optimal stochastic control of the

modes of operation of SPS for SPS, the structure of which is shown in Fig 2.

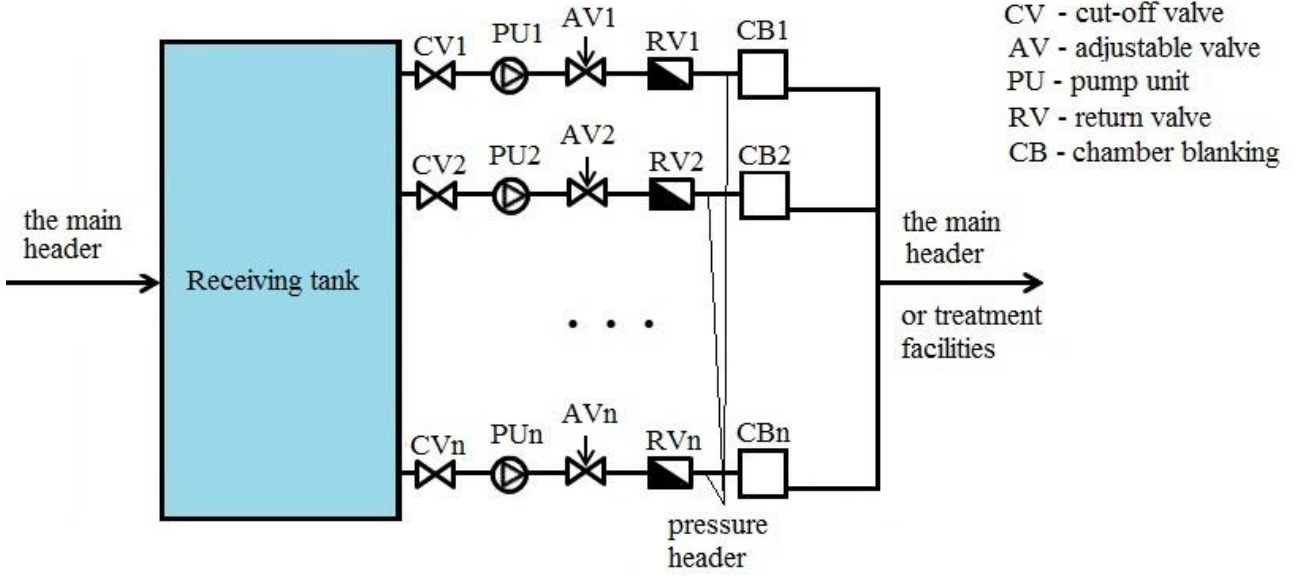

Fig. 2. Typical structure of SPS

The interval of control $[0, T]$ (a day) is divided into 24 subintervals corresponding to each hour $k=0, \dots, 23$. We assume that at $k=0$ the predictions of inflows of WW into RT \bar{q}_{vh0} are known in the form of conditional mathematical expectations (ME) of future volumes of the inflow of WW, calculated at the time interval $k=0$, proactively $l=1, 2, \dots, 23$; ME of the level of WW in RT of SPS- \bar{H}_0 ; ME of the number of operating PU - \bar{m}_0 . The static data are also known: the structure of SPS, lengths, diameters, geodetic marks of the sections of pressure header, the types of PU, the evaluations of the parameters of PU models, physical dimensions of RT, the evaluations of the parameters of AV, cut-off valves and return valves.

The objective function of the problem of optimal stochastic control of the modes of operation of SPS at the time interval $[0, T]$ is ME of the sum of the electricity costs by all operating PU at the time interval $[0, T]$:

$$M_{\omega} \sum_{k=0}^{23} \sum_{i=1}^m N_{ik}(q_{ik}(\omega)) \cdot s_k \rightarrow \min_{u^{(k)} \in \Omega}, \quad (1)$$

the area of restrictions Ω is determined by the stochastic model of quasi-stationary modes of operation of the pumping station (PS) [21-25]

$$M_{\omega} (h_{KNSk}(\omega) - H_k(\omega) - h_{NArk}(q_{rk}(\omega)) + h_{RZrk}(q_{rk}(\omega)) + \sum_{i \in M} b_{1ri} (h_{ik}(q_{ik}(\omega)) + h_i^{(s)})) = 0, \quad (r=1, \dots, m), \quad (2)$$

$$q_{vihk}(\omega) = \sum_{r=1}^m q_{rk}(\omega), \quad q_{rk}(\omega) > 0, \quad (3)$$

$$h_{ik}(q_{ik}(\omega)) = \text{sgn} q_{ik}(\omega) S_i(\omega) q_{ik}^2(\omega), \quad i \in M, \quad (4)$$

$$h_{NAik}(q_{ik}(\omega)) = a_{0i}(\omega) + a_{1i}(\omega) q_{ik}(\omega) + a_{2i}(\omega) q_{ik}^2(\omega), \quad i \in L, \quad (5)$$

$$\eta_{NAik}(q_{ik}(\omega)) = d_{0i}(\omega) + d_{1i}(\omega) q_{ik}(\omega) + d_{2i}(\omega) q_{ik}^2(\omega), \quad i \in L, \quad (6)$$

$$N_{NAik}(q_{ik}(\omega)) = \frac{9,81 \cdot h_{NAik}(q_{ik}(\omega)) \cdot q_{ik}(\omega)}{0,9 \cdot \eta_{NAik}(q_{ik}(\omega))}, \quad i \in L, \quad (7)$$

$$h_{RZik}(q_{ik}(\omega)) = \frac{q_{ik}(\omega) C_i(\omega)}{E_{ik}^2}, \quad i \in R, \quad (8)$$

the stochastic model of RT:

$$M_{\omega} \{H_k(\omega) - H_{k-1}(\omega) - c_k(q_{vhk}(\omega) - q_{vihk}(\omega))\} = 0, \quad (9)$$

probabilistic and extreme constraints on the phase variables fixed at the time interval $k=6, k=23$:

$$P(H_k(\omega) \leq H^{\max}) \geq \alpha, \quad \alpha \approx 0,97, \quad (10)$$

$$P(H_k(\omega) \geq H^{\min}) \geq \alpha, \quad \alpha \approx 0,97, \quad (11)$$

$$M_{\omega} \{H_6(\omega)\} \rightarrow \min_{q_{vhk} \in \Omega}, \quad (12)$$

$$M_{\omega} \{H_{23}(\omega)\} \rightarrow \max_{q_{vhk} \in \Omega}, \quad (13)$$

where $u^{(k)}$ - vector of control which determines the amount of operating PU, the position of AV; $H_k(\omega)$ - level of WW in RT of SPS at a given k time interval, H^{\min} - minimum allowable level of WW in RT of SPS, H^{\max} - maximum allowable water level in RT of SPS under certain initial conditions \bar{m}_0, \bar{H}_0 .

Random variables characterize: $q_{ik}(\omega)$ - WW consumption on i section of the pressure header at k time interval; $h_{ik}(q_{ik}(\omega))$ - evaluation of the head fall on i section of the pressure header at k time interval; $h_{KNSk}(\omega)$ - water head at the output of SPS, $h_{NAik}(q_{ik}(\omega))$ - water head of i PU; $q_{vhk}(\omega), q_{vihk}(\omega)$ - WW consumption at the input and output of RT at k time interval. $S_i(\omega)$ - evaluation of the hydraulic resistance on i section of the pressure header ($i \in M$); $h_{RZik}(q_{ik}(\omega))$ - evaluation of

the head fall on i AV; $\eta_{NAik}(q_{ik}(\omega))$ – evaluation of the coefficient of efficiency of i PU; $a_{0i}(\omega), a_{1i}(\omega), a_{2i}(\omega), d_{0i}(\omega), d_{1i}(\omega), d_{2i}(\omega)$ – evaluations of the parameters of PU ($i \in L$); $C_i(\omega)$ – evaluations of the parameters of AV ($i \in R$); E_{ik} – rate of the opening of AV ($E \in (0,1]$); c – coefficient inversely related to the area of RT; $h_i^{(g)}$ – geodesic mark of i section of the pressure header ($i \in M$); $N_{NAik}(q_{ik}(\omega))$ – evaluation of the power by i PU at k time interval; m – number of PU on SPS; s_k – electricity tariff at k time interval; $M_{\omega} \{ \}$ – ME of corresponding random variables, enclosed in brackets $\{ \}$.

The problem of optimal stochastic control of the modes of operation of SPS (1) - (13) belongs to the class of nonlinear problems of optimal stochastic control with discrete time, probabilistic and extreme constraints on the phase variables [2, 11, 19, 20]. There aren't any exact solutions of the problems of such a class nowadays. The approximate method of solving the examined problem by the transition from stochastic problem (1) - (13) to its deterministic equivalent the decision of which is carried out by the modified method of branches and bounds is given in the present work.

THE DETERMINISTIC EQUIVALENT OF THE PROBLEM OF OPTIMAL STOCHASTIC CONTROL OF THE MODES OF OPERATION OF SPS

The deterministic equivalent [8, 9] of the problem of optimal stochastic control of the modes of operation of SPS per day (1) - (13) can be represented as:

$$\sum_{k=0}^{23} \sum_{i=1}^m \bar{N}_{ik}(\bar{q}_{ik}) \cdot s_k \rightarrow \min_{u(k) \in \Omega}, \quad k = 0, \dots, 23, \quad (14)$$

$$\bar{h}_{NSjk} - \bar{H}_k - \bar{h}_{NAjrk}(\bar{q}_{rk}) + \bar{h}_{RZjrk}(\bar{q}_{rk}) + \sum_{i \in M} b_{lri}(\bar{h}_{ik}(\bar{q}_{ik}) + h_i^{(g)}) = 0, \quad (r = 1, \dots, m), \quad (15)$$

$$\bar{q}_{vihk} = \sum_{r=1}^m \bar{q}_{rk}, \quad \bar{q}_{rk} > 0, \quad (16)$$

$$\bar{h}_{NAik}(\bar{q}_{ik}) = \bar{a}_{0i} + \bar{a}_{1i} \bar{q}_{ik} + \bar{a}_{2i} \bar{q}_{ik}^2, \quad i \in L, \quad (17)$$

$$\bar{\eta}_{NAik}(\bar{q}_{ik}) = \bar{d}_{0i} + \bar{d}_{1i} \bar{q}_{ik} + \bar{d}_{2i} \bar{q}_{ik}^2, \quad i \in L, \quad (18)$$

$$\bar{N}_{NAik}(\bar{q}_{ik}) = \frac{9,81 \cdot \bar{h}_{NAik}(\bar{q}_{ik}) \cdot \bar{q}_{ik}}{0,9 \cdot \bar{\eta}_{NAik}(\bar{q}_{ik})}, \quad i \in L, \quad (19)$$

$$\bar{h}_{RZik}(\bar{q}_{ik}) = \frac{\bar{q}_{ik} \bar{C}_i}{E_{ik}^2}, \quad i \in R, \quad (20)$$

$$\bar{h}_{ik}(\bar{q}_{ik}) = \text{sgn} \bar{q}_{ik} \bar{S}_i \bar{q}_{ik}^2, \quad i \in M, \quad (21)$$

$$\bar{H}_k = \bar{H}_{k-1} + c_k (\bar{q}_{vhk} - \bar{q}_{vihk}), \quad (22)$$

$$H^{-*} \leq \bar{H}_k \leq H^{+*}, \quad (k=1,2,\dots,23), \quad (23)$$

$$\bar{H}_6 \rightarrow \min_{q_{vhk} \in \Omega}, \quad (24)$$

$$\bar{H}_{23} \rightarrow \max_{q_{vihk} \in \Omega}, \quad (25)$$

where H^{-*}, H^{+*} - calculated values of the minimum and maximum levels of WW in RT of SPS where for $\forall \omega \in \Omega$ probabilistic constraints (10) – (11) will be fulfilled under certain initial conditions \bar{m}_0, \bar{H}_0 .

THE METHOD OF SOLVING THE DETERMINISTIC EQUIVALENT OF THE PROBLEM OF OPTIMAL STOCHASTIC CONTROL OF THE MODES OF OPERATION OF SPS.

To solve the deterministic equivalent of the problem of optimal stochastic control of the modes of operation of SPS (14) - (25) we will use the modified method of branches and bounds.

Initial data:

P - vector of dimension [24x1] defining the predicted values for the inflow of WW at the planning interval.

n - maximum quantity of similar PU which can be switched on SPS ($n = 5$).

T - vector of dimension [24x1] defining the three-band tariff for the electricity, T_i - electricity tariff at the time interval $[i-1, i]$ ($i = 1, \dots, 24$).

\bar{H}_0 - ME of the level of WW in RT of SPS at the beginning of the interval of control.

Allowable limits of the change of the level of WW in RT of SPS $[H_{\min}, H_{\max}] = [3, 2; 5, 9]$.

Physical dimensions of RT of SPS: $V = 4727 m^3$; $H = 6 m$.

ME of the WW flow in the operating point of PU: $q_0 = 4180 m^3 / s$

The planning interval $[0, T]$ (one day) is divided into three subintervals k_1, k_2, k_3 ($k_j, j = 1, 2, 3$) according to the three-band tariff. We will consider the planning interval one day as a set of time subintervals $S = \{1, 2, \dots, 24\}$, then in accordance with the three-band tariff the set $S_1 = \{1, 2, \dots, 5, 23, 24\}$ corresponds to the time interval with minimal tariff, with medium tariff – the set $S_2 = \{6, 7, 10, 11, \dots, 17, 22\}$, with maximal tariff – the set $S_3 = \{8, 9, 18, 19, \dots, 21\}$. S_1, S_2, S_3 - noncrossing sets $S_1 \cap S_2 \cap S_3 = \emptyset$ and $S = S_1 \cup S_2 \cup S_3$.

OptStoim - a large number;

Conventional signs of intermediate data:

q - vector of dimension [24x1] determining ME of the total flow rate of WW on SPS of all subintervals of the set S (m^3/s);

U - vector of dimension [24x1] defining ME of the level of WW in RT of SPS of all subintervals of the set S, U_i - level of WW in RT of SPS by the end of i time interval (m);

$$u_{roven} = \begin{cases} 1, & \text{if } \forall U_i \in U : U_i \in [H_{\min}, H_{\max}], \\ -6, & \text{if } \exists \text{ at least one } U_i \in U : U_i < H_{\min}, \\ 6, & \text{if } \exists \text{ at least one } U_i \in U : U_i > H_{\max}. \end{cases} \quad (26)$$

m, m^* - values equal to the sum of the products of the number of operating PU and the time (h) spent on the operation at the planning interval for certain modes of operation of SPS.

Stoim – ME of the sum of the cost value for the electricity consumed by all operating PU at the interval of control.

The algorithm for finding the optimal mode of operation of SPS:

1. Preset T, P, n, \bar{H}_0 , OptStoim, H_{\min}, H_{\max} , $j = 0$.

Knowing P and q_0 determine ME of the number of operating PU m.

2. $j := j + 1$. For the subinterval k_j : set the R mode of operation of SPS (the number of operating PU for each hour of the day) $R_i = n$, ($i \in S_j$).

3. Expect q, U, uroven.

If uroven = -6, then come back to the point 2.

4. Set the new mode of operation of SPS R by the way of search of all possible combinations of switching PU: $R_i = 0, 1, \dots, n$, ($i \in S_j$).

5. If for the new mode R the conditions $\sum_{i \in S_j} R_i > m$ or $\sum_{i \in S_j} R_i < m - 1$ are met, then we come back to the point 4.

6. We expect q, U, uroven.

If uroven=1, then we calculate Stoim.

If uroven≠1, then come back to the point 4.

7. If Stoim<OptStoim, then OptStoim:=Stoim.

8. For the mode R mode calculating m^* ; if $m^* < m$, then $m := m^*$.

9. Conclusion Stoim; R; U. Come back to the point 4.

10. Selection of the optimal values Stoim*; R*; U*.

Fig. 3 shows a flowchart of the algorithm of searching of the optimal mode of operation of SPS at the interval of control $[0, T]$.

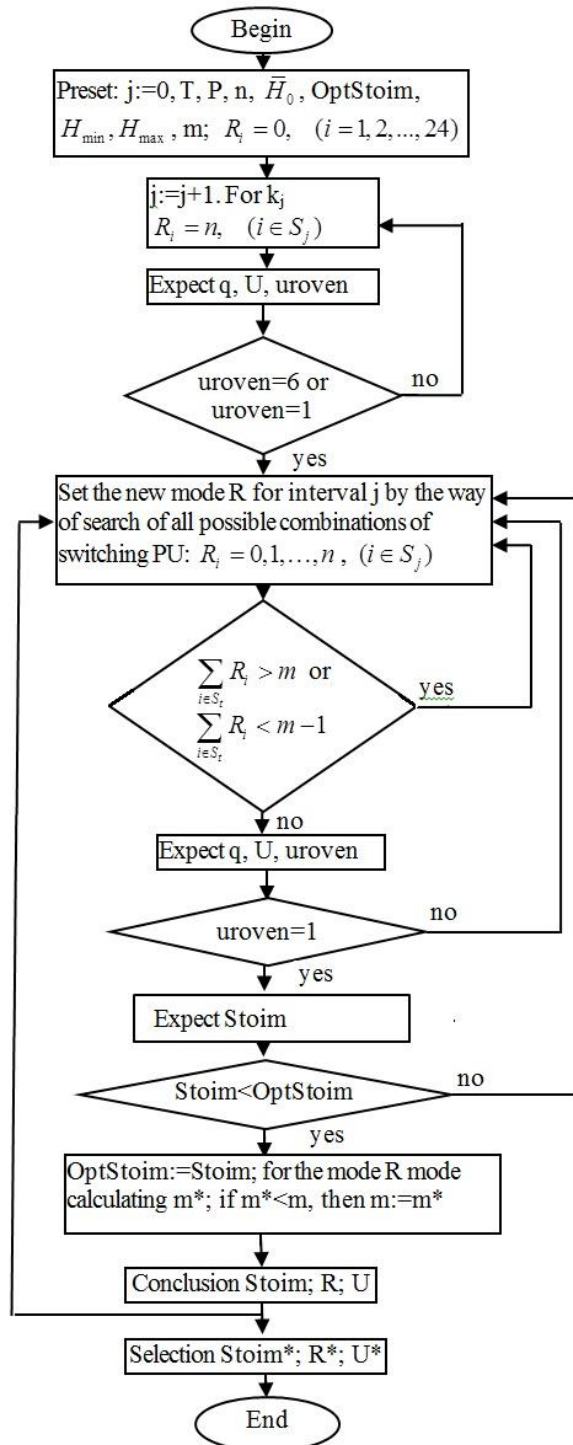

Fig. 3. Flow chart of the algorithm of searching of the optimal mode of operation of SPS at the interval of control $[0, T]$

As a result of the solution of the problem (14) - (25) of optimal stochastic control of the modes of operation of SPS for each time interval k , we obtain:

1. ME of the vector of control $u(k)$, including: the number of operating PU, the position of the operating point of each PU;
2. estimates of ME of the levels of WW in RT of SPS;
3. estimates of the pressure-flow rate and pressure drop for all technological elements of SPS;
4. estimates of ME of the expenses for the electricity and its value in accordance with the three-band tariff by all operating PU.

At the time interval $k = 23$, we obtain the evaluation of ME of the total cost of the electricity consumed by SPS at the interval of control $[0, T]$.

RESULTS AND DISCUSSION

The evaluation of the effectiveness of the proposed method was carried out for SPS shown in Fig. 2. equipped with five PU type FLYGT CT 3531 and four PU type SDV 9000/45, whose passport characteristics are shown in Fig. 4, the approximated parameters in Table 1.

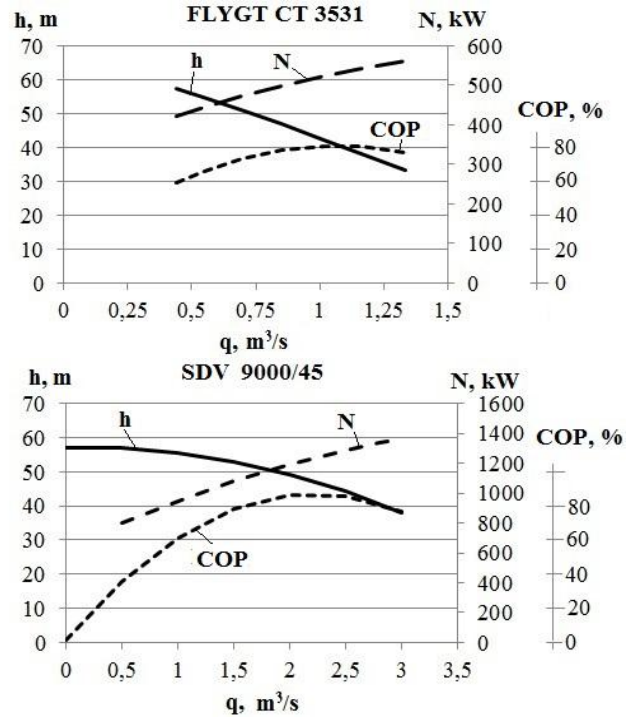

Fig.4. The characteristics of the pump units FLYGT CT 3531 and SDV 9000/45

Table 1. Estimates of ME of the parameters of the approximating functions H-Q and COP-Q

Type of PU	\bar{a}_0	\bar{a}_1	\bar{a}_2	\bar{d}_0	\bar{d}_1	\bar{d}_2
FLYGT CT 3531	67,55976	-22,2469	-2,54534	18,33433	116,416	-54,1789
SDV 9000/45	57,22619	0,82143	-2,40476	1,428571	77,2857	-17,4286

The initial data for the problem of optimal stochastic control of the modes of operation of SPS at the interval of control $[0, T]$ are:

- statistical data, including the structure of SPS; lengths; diameters; geodetic marks of the sections of the pressure header; evaluations of the parameters of mathematical models of all PU; evaluations of hydraulic resistances of all AV; physical dimensions of RT;

- dynamic data, including the prediction of inflow of WW into RT of SPS per day.

RT has the following physical dimensions: height - 6 m, capacity - 4728 m³. The minimum allowable level of WW in RT - 3,2 m, the maximum allowable level of WW in RT - 5,9 m. Lengths, diameters and geodetic marks of pressure headers, respectively: $l = 350$ m, $d = 1,1$ m, $h^g = -31,65$ m. The diagram of prediction of the inflow of WW in RT per day is shown in Fig. 5.

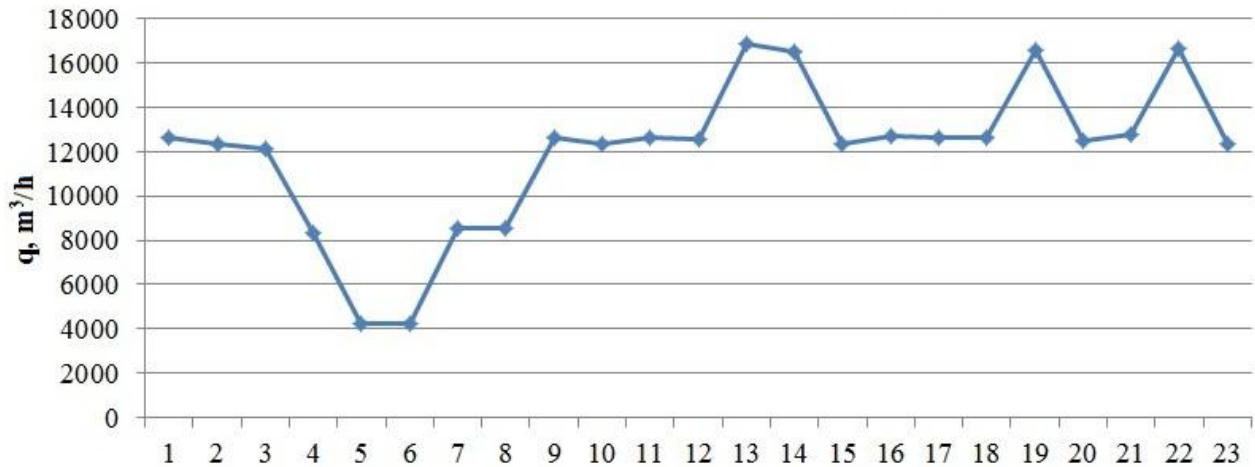

Fig. 5. The diagram of prediction of inflow of WW in RT per day

At time zero $k = 0$ for the actual and optimal mode the same conditions have been used: ME of the level of WW in RT $H_0 = 5,1$ m; three PU type Flygt operated on SPS. For the

actual mode the single-band tariff 1,238 has been used; for the optimal mode - the three-band tariff.

The results of solving the problem of optimal stochastic control of the modes of operation of SPS are shown in Table 2 and Fig. 6.

Table 2. ME of the number of operating PU at the interval of control [0,23] for the actual and optimal modes of operation of SPS.

Hours	Tariff	Actual mode		Optimal mode	
		ME of the number of operating PU type FLYGT	ME of the levels of WW in RT, m	ME of the number of operating PU type FLYGT	ME of the levels of WW in RT, m
1	0,25	3 PU	5,2	5 PU	4,78
2	0,25	3 PU	5,3	5 PU	4,47
3	0,25	3 PU	5,1	5 PU	4,15
4	0,25	3 PU	4,6	5 PU	3,83
5	0,25	2 PU	4,6	5 PU	3,39
6	1,02	1 PU	4,7	1 PU	3,39
7	1,02	1 PU	4,8	-	3,54
8	1,8	2 PU	5	-	3,84
9	1,8	2 PU	5,2	-	4,14
10	1,02	3 PU	5,3	2 PU	4,29
11	1,02	3 PU	5,1	5 PU	3,98
12	1,02	3 PU	5,2	5 PU	3,68
13	1,02	3 PU	5,2	5 PU	3,39
14	1,02	4 PU	5,4	4 PU	3,40
15	1,02	4 PU	5,1	5 PU	3,25
16	1,02	3 PU	4,9	1 PU	3,54
17	1,02	3 PU	5,1	2 PU	3,69
18	1,8	3 PU	5,2	-	4,14
19	1,8	3 PU	5,3	-	4,58
20	1,8	4 PU	5,1	-	5,17
21	1,8	3 PU	5	-	5,60
22	1,02	3 PU	5,3	1 PU	5,90
23	0,25	4 PU	5,2	5 PU	5,71
24	0,25	3 PU	5	5 PU	5,37

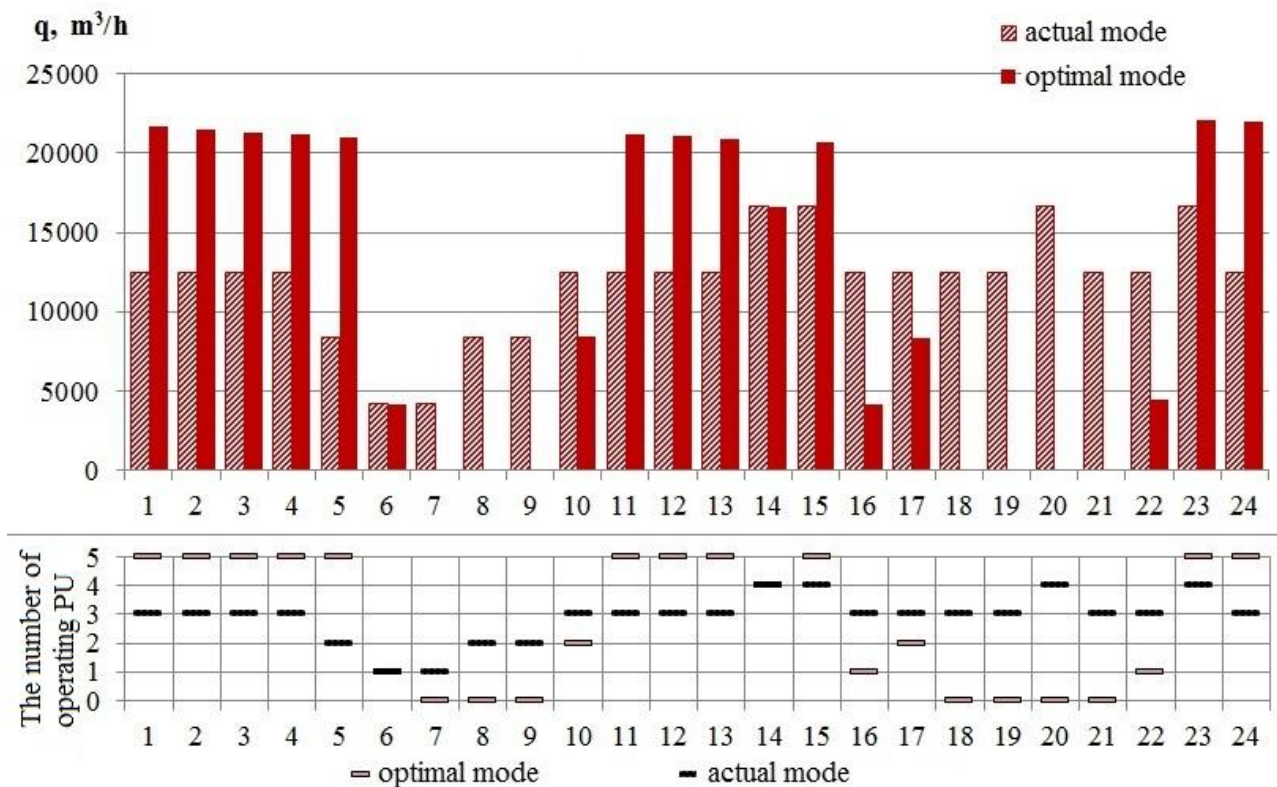

Fig. 6. ME of the volume of WW pumped by SPS at the interval of control [0,23] and ME of the number of operating PU for the actual and optimal modes of operation

Table 3 presents the estimates of ME of power and cost value for the electricity at the interval of control [0,23] for the actual and optimal modes of operation of SPS.

Table 3. The comparative analysis of ME of the parameters of actual and optimal modes of operation of SPS.

Parameters	Actual mode	Optimal mode
N, kW	38154,21	36061,73
Cost, UAH	47234,91	22009,45

The analysis of the results in Table 3 leads to the conclusion that while the transition to the three-band tariff for the electricity and use of the proposed algorithm of optimal stochastic control significant savings in the cost for the electricity from 47234,91 UAH. to 22009.45 UAH. can be provided, which is 53,4% less than the previous amount.

Pic. 7 presents the change of the estimate of ME of the cost value for the electrical energy while the transition from the actual to the optimal mode.

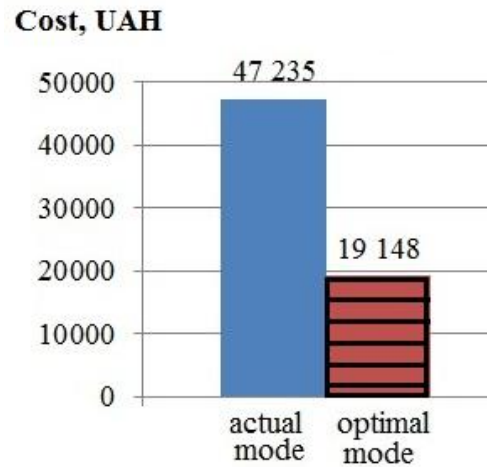

Fig. 7. The estimate of ME of the cost value for the electricity consumed by SPS at the interval of control [0,23]

Fig. 8 shows that under the optimal mode of operation of SPS the capacity of RT is used more efficiently.

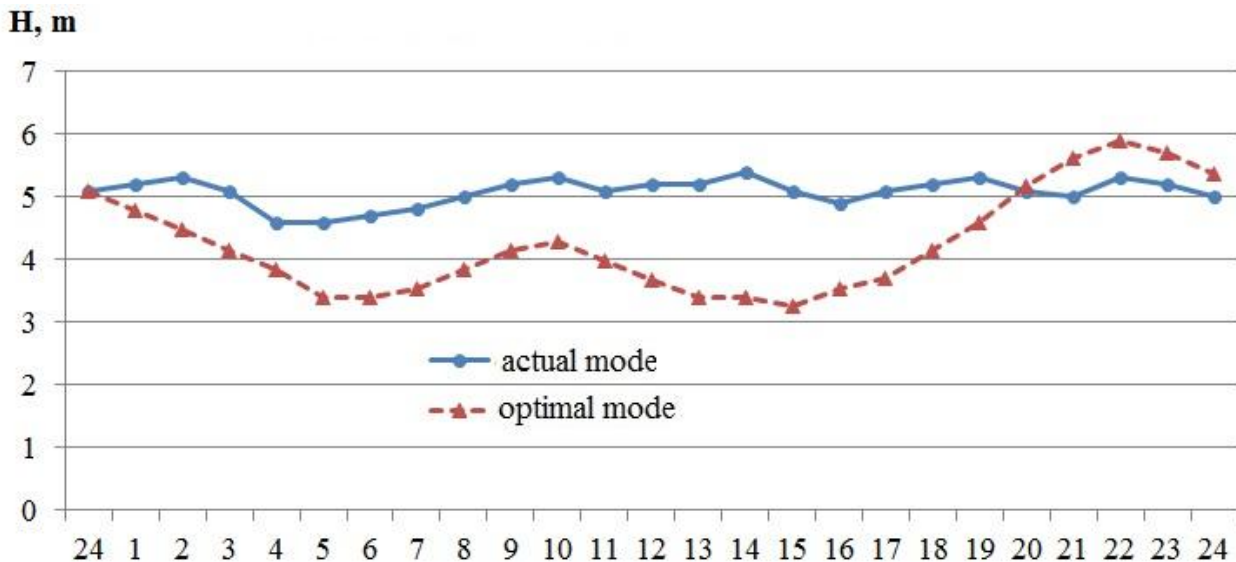

Fig. 8. ME of the changes of levels of WW in RT of SPS for the actual and optimal modes of operation of SPS

Thus, it can be seen from Fig. 8, that by 11 p.m. ME of the levels of WW in RT reaches its maximum value and by 6 a.m. its minimum value.

Practical application of the proposed mathematical model and method of optimal stochastic control of the modes of operation of SPS and the transition to the three-band tariff for the electricity provides a significant saving in financial expenses of SPS for pumping WW at the interval of control [0, T].

CONCLUSIONS

Scientific novelty:

1. for the first time SPS is represented as a stochastic object of control operating in the stochastic environment, it allowed to take into account adequately the specific characteristics of stochastic processes of the inflow of WW into RT of SPS and the stochastic properties of technological equipment of SPS which gave the possibility to present the problem of optimal control of the modes of operation of SPS as the problem of optimal stochastic control with discrete time with probabilistic and extreme constraints on the phase variables;

2. for the first time the effective method for solving the problem of optimal stochastic control of the modes of operation of SPS by the transition to its deterministic equivalent and its solutions by the modified method of branches and bounds has been proposed.

Practical value:

The estimates of the effectiveness of the proposed mathematical model and method of optimal stochastic control while the transition to the three-band tariff for the electricity was carried out using the example of the main SPS (SSPS) of one of the largest cities of Ukraine. It is shown that the use of the proposed method in comparison with the currently used method of control of the modes of SSPS allows significantly (up 53%) to reduce the cost value for the electricity, for pumping WW SSPS at the interval of control [0, T].

REFERENCES

1. **Abramov N. 1974.** Water Supply. M. : Stroyizdat, 481. (in Russian)
2. **Bertsekas D., Shreve S. 1985.** Stochastic Optimal Control. The Discrete Time Case. M. : Nauka, 280. (in Russian)
3. **Bohan A., Kolesnik Y. 2002.** Optimization of modes of power consumption of pump units of water and sewage. Herald GSTU behalf of Sukhoi P. №2 (8), 41-48. (in Russian)
4. **Burgschweiger J., Gnadig B., Steinbach, M. C. 2009.** Optimization Models for Operative Planning in Drinking Water Networks. Optimization and Engineering Vol. 10, №1, 43-73.
5. **Burgschweiger J., Gnadig B., Steinbach M. C. 2009.** Nonlinear Programming Techniques for Operative Planning in Large Drinking Water Networks. The Open Applied Mathematics Journal, №3, 14-28.
6. **Chupin R. V., Melekhov E. S. 2011.** The Theory and Practice of Modeling and Optimization of Water and Wastewater. – Irkutsk. : Publisher Irkutsk State Technical University, 323. (in Russian)
7. **Dolinskii A., Draganov B., Kozirskii V. 2012.** Nonequilibrium State of Engineering systems. Econtechmod. An International Quarterly Journal. Vol. 1, № 1, 33–34.
8. **Evdokimov A.G., Dubrovsky V.V., Teviashev A.D. 1979.** Flow Distribution in the Network Engineering. M. ; Stroyizdat, 199. (in Russian)
9. **Evdokimov A.G., Teviashev A.D. 1980.** Operational Management of Load Flow in Engineering Networks. Kharkiv. ; High School, 144. (in Russian)
10. **Galeev A Suleimanov P, Arslanov I. 2013.** Automated Monitoring and Control System of Sewerage Pumping Station Pumping Units' Work. Engineering - from theory to practice. №24, 13-20. (in Russian)
11. **Hoeve W.-J. 2005.** Operations Research Techniques in Constraint Programming. Institute for Logic, Language and Computation Universiteit van Amsterdam, 154.
12. **Karelin V.Y., Minayev A.V. 1986.** Pumps and pumping stations. M. ; Stroyizdat, 320. (in Russian)
13. **Leznov B.C. 2006.** Energy saving and adjustable drive for pump and blower installations. M. : Energoatomizdat, 358. (in Russian)
14. **Lipták B. 2009.** Pumping Station Optimization. Control Promoting Excellence in Process Automation, 12 – 19. (in Russian)
15. **Lobachev P.V. 1983.** Pumps and pumping stations. M. ; Stroyizdat, 191. (in Russian)
16. **Mathews J.H., Fink K.K. 2004.** Numerical Methods Using Matlab., 4th Edition, Prentice-Hall Inc. Upper Saddle River, New Jersey, USA, 440.
17. **Pulido-Calvo I. Gutiérrez-Estrada J.C. 2011.** Selection and Operation of Pumping Stations of Water Distribution Systems. Environmental Research Journal, Nova Science Publishers, 1-20.
18. **Ruuskanen A. 2007.** Optimization of Energy Consumption in Wastewater Pumping. Lappeenranta University of Technology Department of Energy- and Environmental Technology, 99.
19. **Steinbach M.C. 2001.** General Information Constraints in Stochastic Programs. Berlin : ZIB, 5.
20. **Steinbach M.C. 2001.** Tree-Sparse Convex Programs. Konrad-Zuse-Zentrum für Informationstechnik Berlin, ZIB-Report, 22.
21. **Teviashev A.D., Matviyenko O.I. 2014.** Stochastic Model and Method of Zoning Water Networks. Kharkov : Eastern-European Journal of Enterprise Technologies, 1 (67), 17–24. (in Russian)
22. **Teviashev A.D., Matviyenko O.I., Nikitenko G.V. 2014.** Stochastic Model and Method of Operational Planning Modes Pumping Stations. "Water. Ecology. Society ": Proceedings of the IV International Scientific - Technical Conference. - Kharkov : O. M. Beketov NUUE, 61–64. (in Russian)
23. **Teviashev A.D., Shulik, P.V. 2002.** Estimation of Parameters of Mathematical Models of the Elements of Pumping Stations in Real Time. ACS and automation devices. Kharkov : Univ KhTURE, 28–37. (in Russian)
24. **Teviashev A.D., Matvienko O.I. 2014.** One Strategy of Operational Planning Mode Pumping Station. East - European Journal of Enterprise Technologies., № 3, 4-9. (in Russian)
25. **Teviashev A.D., Matvienko O.I. 2014.** About One Approach to Solve the Problem of Management of the Development and Operation of Centralized Water-Supply Systems. Econtechmod. An International Quarterly Journal. Vol. 3, № 3., 61-76.
26. **Velikanov N., Korjagin S. 2014.** Energy Efficiency of Water Supply and Out Water-Way Networks of City. Technical and Technological Problems of Service. №4 (30), 84-88. (in Russian)
27. **Wróbel K., Styła S. and Sumorek A. 2012.** Use of GIS Systems in the Construction of Hydraulic Model of Networks. Econtechmod. An International Quarterly Journal. Vol. 01, № 2., 63-69.